

980891

1.

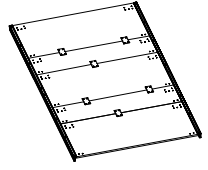

2.

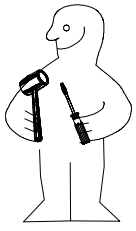
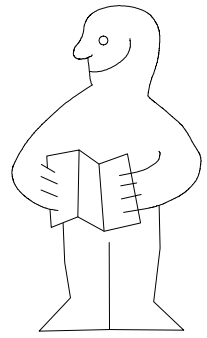
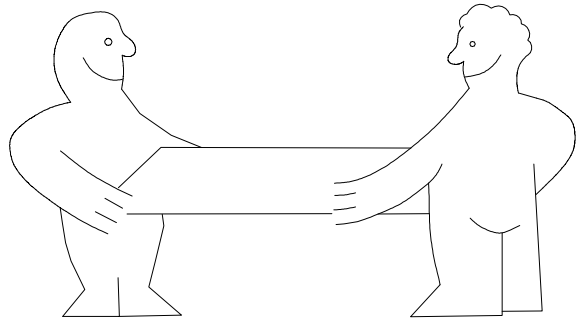
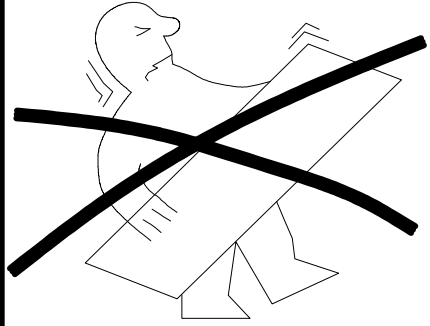
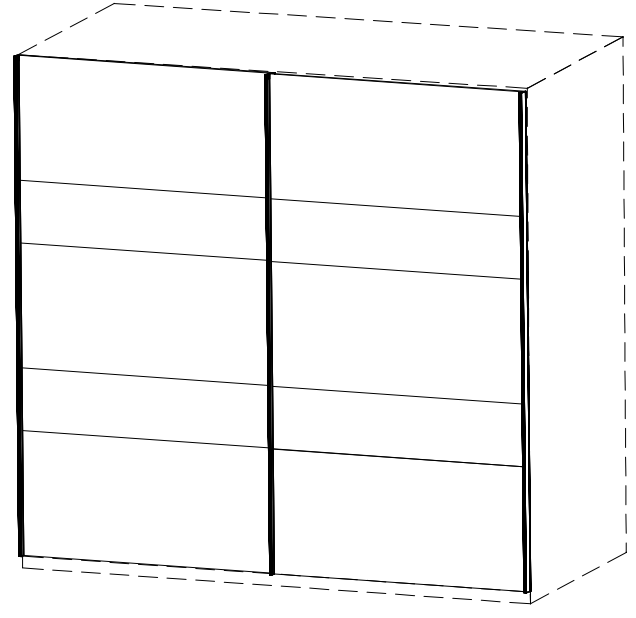
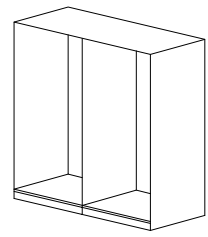
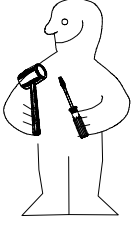

1-2-3-4... ○

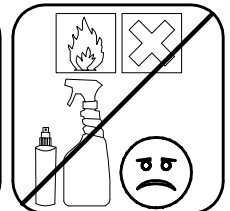
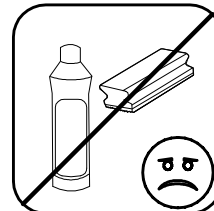
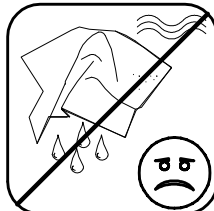
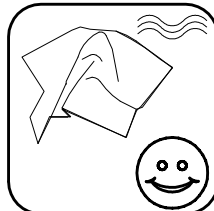
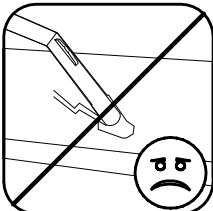
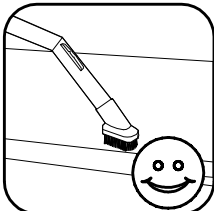
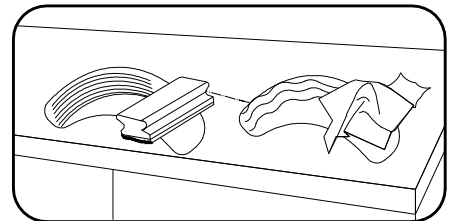
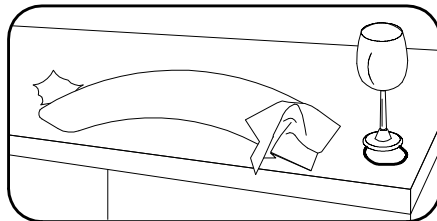
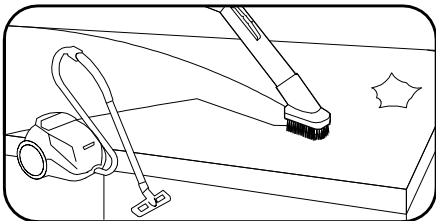
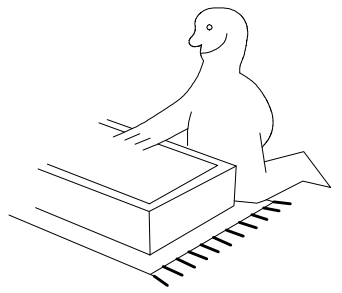
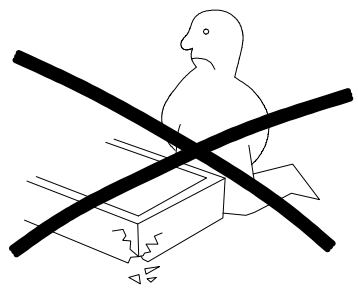
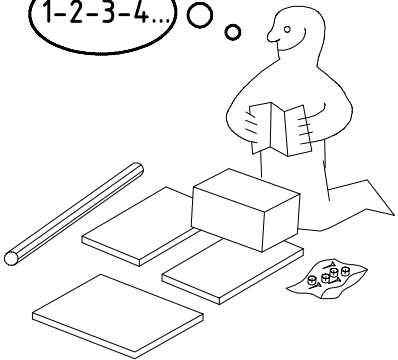

1x
FPN

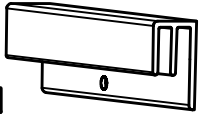

1316/
1760/2204/2648/3092

1x
LP

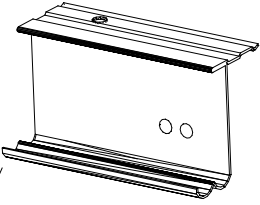

1316/
1760/2204/2648/3092

	2x
	1x
	1x
	2x
	2x

	1x
	1x
	1x
	2x
	2x

	95x
	10x
	24x
	12x

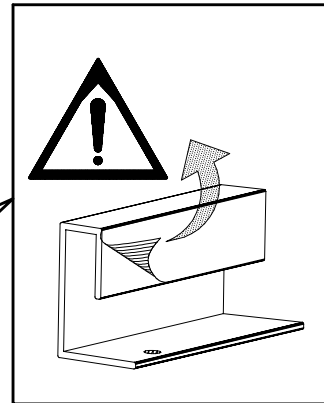
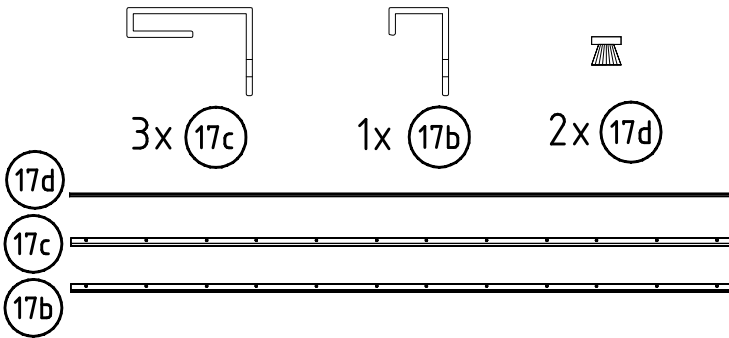
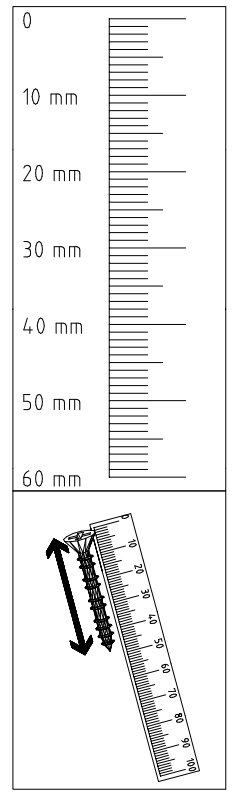
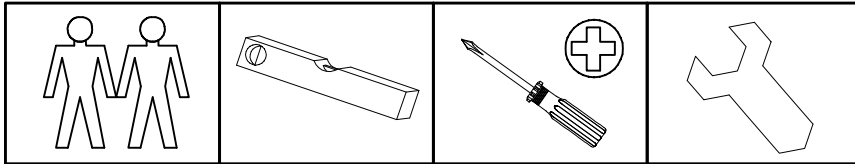
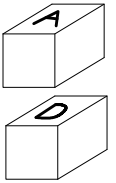

4x 695 / 916 / 1135 / 1357 / 1579 x 252 x 15

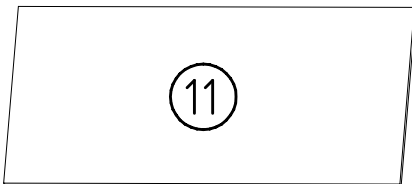
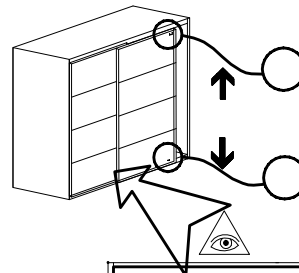

6x 695 / 916 / 1135 / 1357 / 1579 x 504 x 15



1

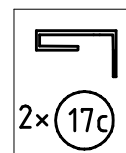
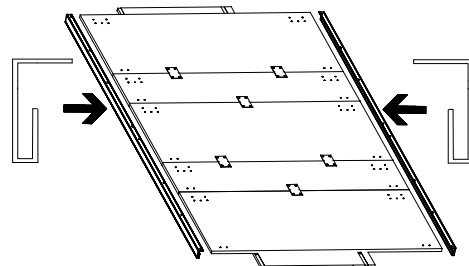
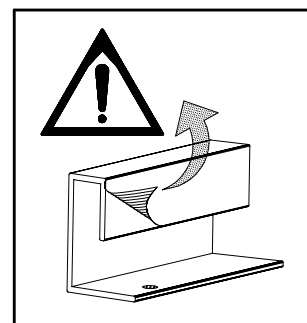
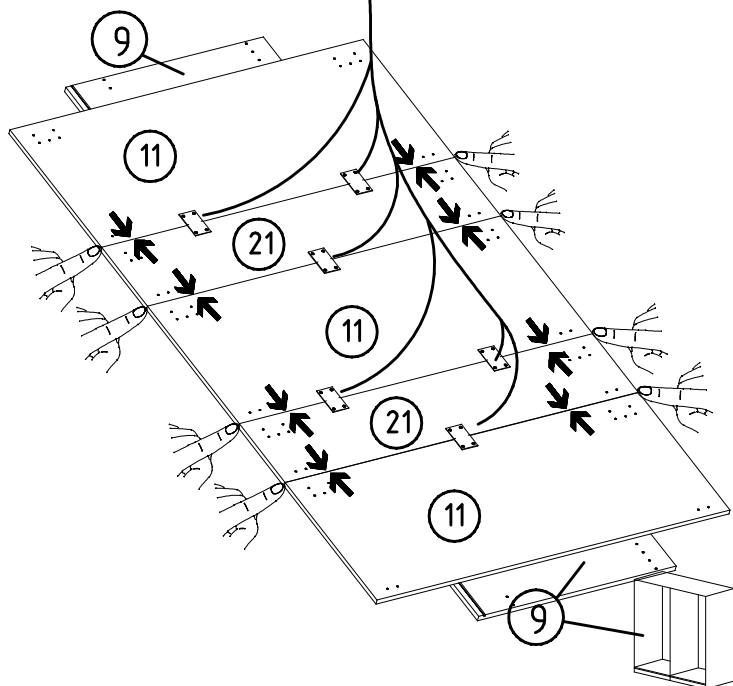
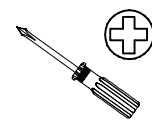
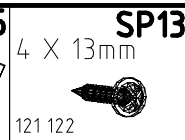
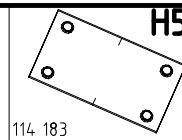
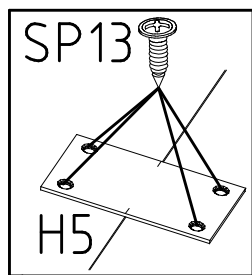
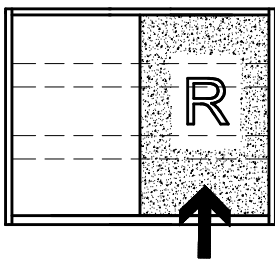

2

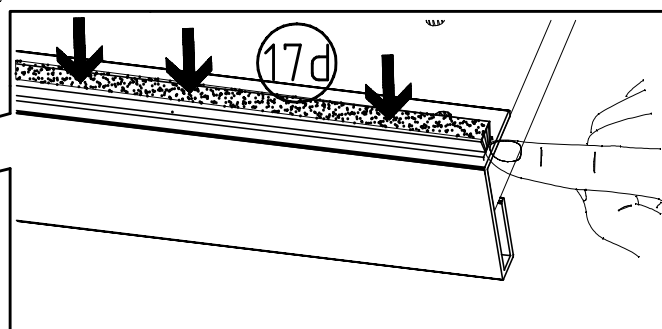
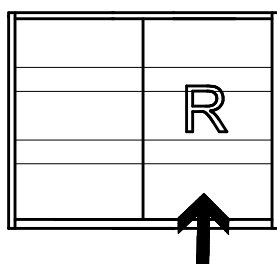
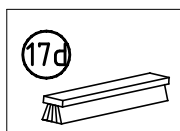
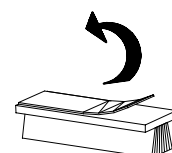
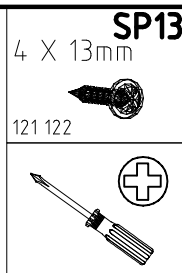
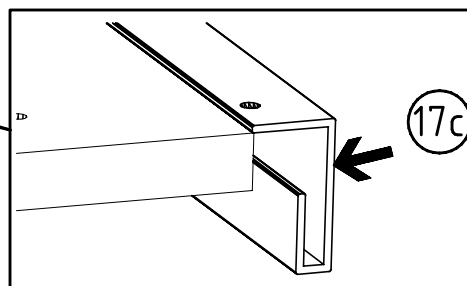
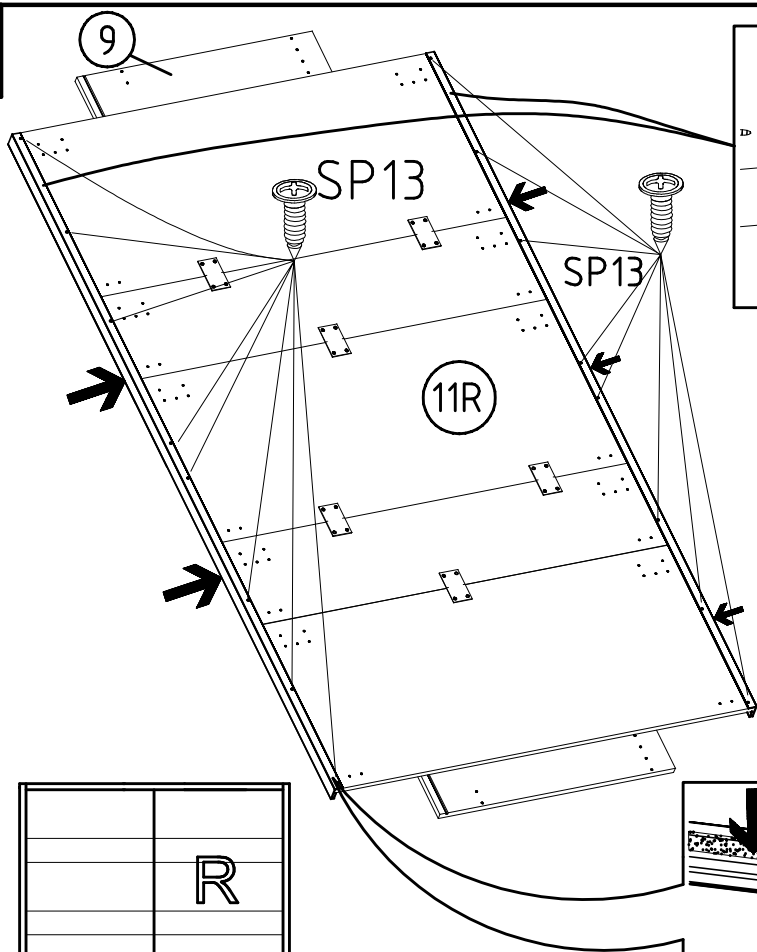

3

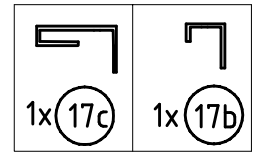
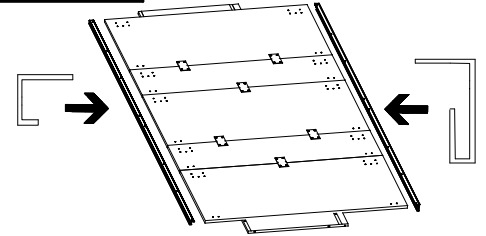
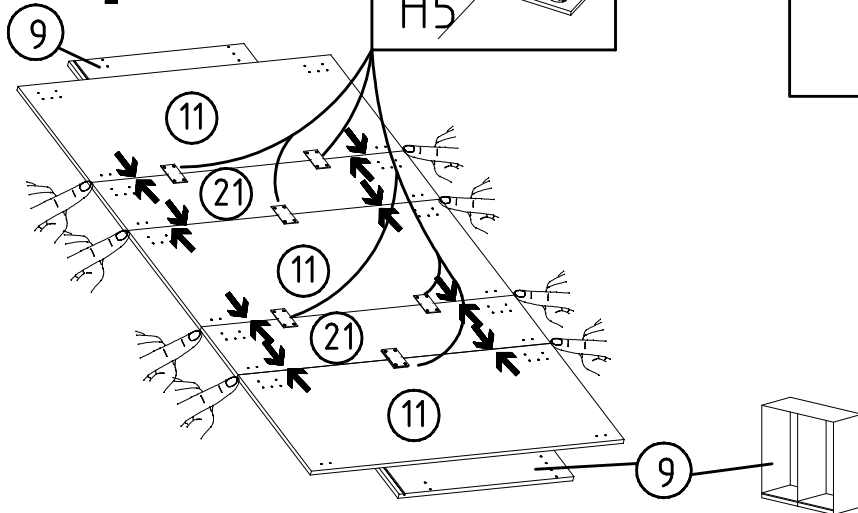
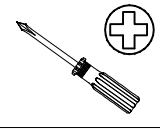
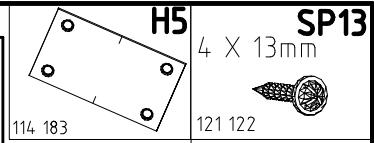
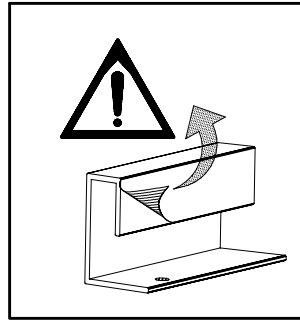
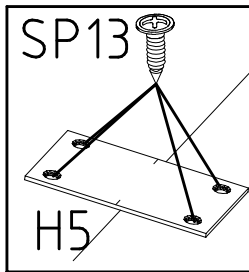
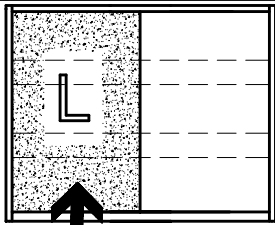

4

