

















Ax1 	Bx1 	Cx2 	Dx1 	Ex1 	Fx1 	Gx1 	Hx5 	Ix4  M6x20mm
Jx9  M6x30mm	Kx2  M6x35mm	Lx3  M8x30mm	Mx1 	Nx1 	Ox13 	Px1 	Qx1 	



General Care :

*For cleaning wipe the surface with a damp (not wet) cloth or sponge or wipe dry with a clean lint free cotton cloth.

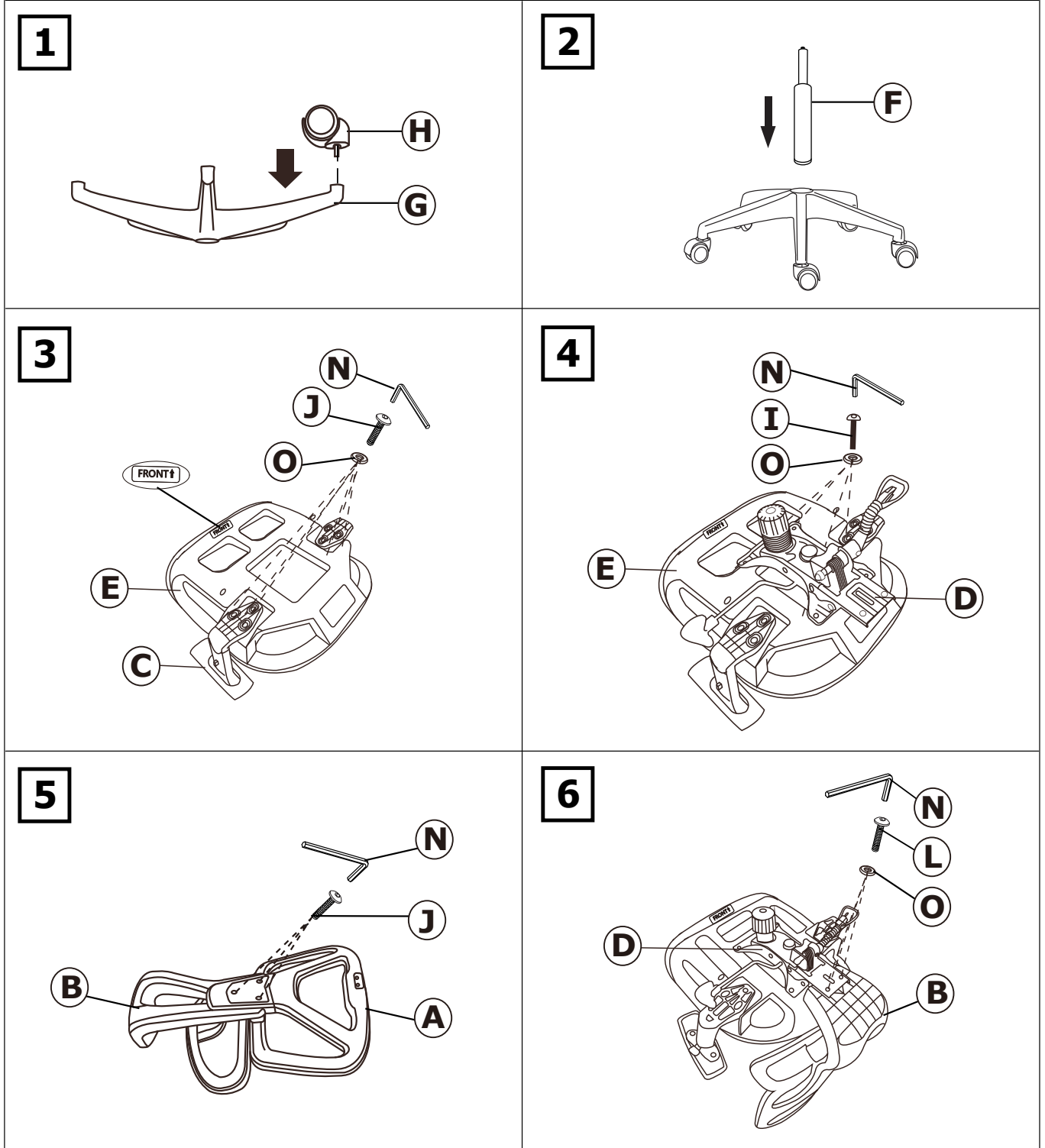
Pokyny k ošetrovaniu:

*K čistení používajte vlhký hadřík nebo houbu, nebo ho otřete suchým nechlupatým bavlněným hadříkem.

Pokyny k ošetrovaniu:

*Na čistenie používajte vlhkú handričku alebo špongiu, alebo ho utrite suchou nechlpatou bavlnenou handričkou.



7

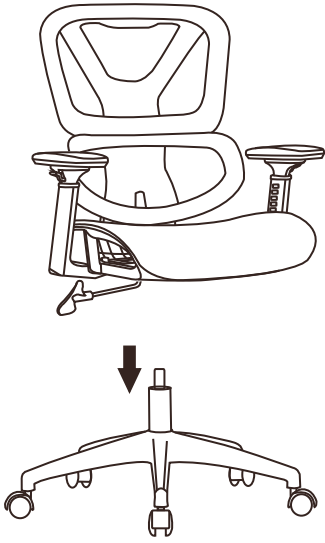

8

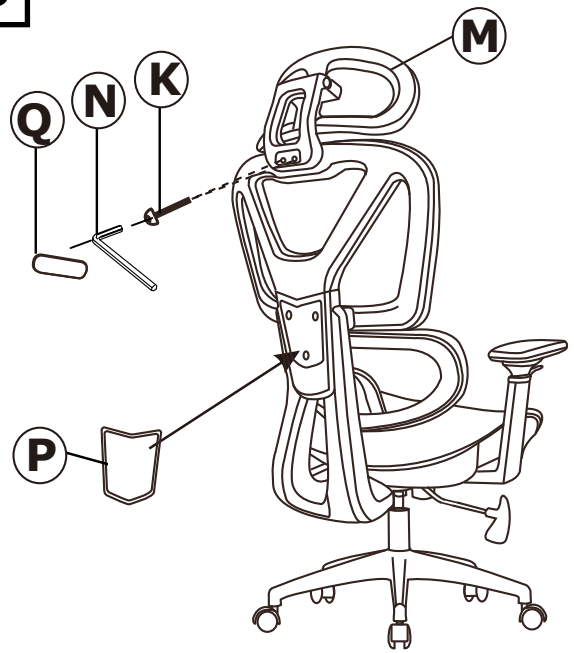

9

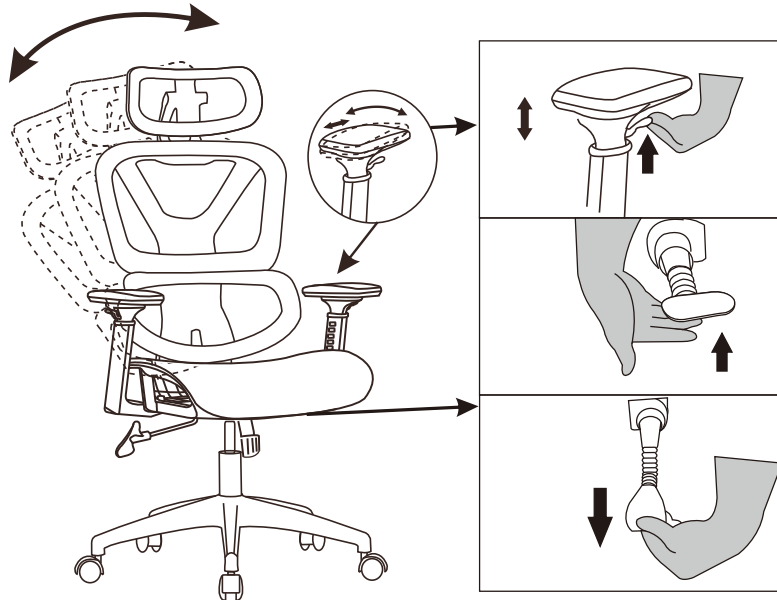

10

